

FINAL SCORE



TCU

12-5/3-3

76



West Virginia

15-3/3-3

74

January 13, 2018 • WVU Coliseum, Morgantown, W.Va.

FINAL STATISTICS

Official Basketball Box Score -- Game Totals -- Final Statistics
 TCU vs West Virginia
 1/13/2018 5:00 p.m. at WVU Coliseum, Morgantown, W.Va.



TCU 76 - 12-5/3-3

##	Player	g	Total		3-Ptr	Rebounds			PF	TP	A	TO	Blk	Stl	Min
			FG-FGA	FG-FGA	FT-FTA	Off	Def	Tot							
01	T HOMPSON,T OREE	g	5-16	2-6	2-2	0	1	1	1	14	0	3	0	0	35
15	WOODS,JAYDE	g	1-4	0-0	1-4	3	1	4	4	3	4	3	1	1	27
21	COLEMAN,SYDNEY	g	0-1	0-1	0-0	0	1	1	0	0	0	1	0	0	6
22	MOORE,JORDAN	c	7-13	0-0	3-4	6	5	11	3	17	1	3	0	0	25
33	AKOMOLAFE,ADEOLA	f	1-3	0-0	1-2	1	1	2	5	3	1	1	0	1	19
00	OKONKWO,AMY		6-11	1-1	3-3	4	8	12	2	16	0	3	1	4	24
04	RAMIREZ,AMBER		1-5	0-3	4-6	0	1	1	1	6	1	3	0	3	17
20	HEARD,LAUREN		1-4	0-1	1-2	1	1	2	0	3	1	1	0	2	15
24	VANN,DAKOTA		0-1	0-1	0-0	0	0	0	1	0	0	2	1	1	13
25	RAY,KIANNA		3-8	0-2	3-5	2	9	11	2	9	4	4	0	3	38
31	HELLESSEY,ELLA		2-3	1-1	0-0	0	0	0	0	5	0	0	0	0	6
TEAM						0	4	4	0						
TOTALS			27-69	4-16	18-28	17	32	49	19	76	12	24	3	15	225

Deadball Rebounds: 6,0

FG %	1st Half: 11-28 39.3%	2nd Half: 13-34 38.2%	OT: 3-7 42.9%	Game: 27-69 39.1%
	1st Qtr 6-17 35.3%	2nd Qtr 5-11 45.5%	3rd Qtr 7-17 41.2%	4th Qtr 6-17 35.3%
3FG %	1st Half: 2-8 25.0%	2nd Half: 1-7 14.3%	OT: 1-1 100.0%	Game: 4-16 25.0%
	1st Qtr 1-4 25.0%	2nd Qtr 1-4 25.0%	3rd Qtr 0-5 00.0%	4th Qtr 1-2 50.0%
FT %	1st Half: 5-9 55.6%	2nd Half: 12-17 70.6%	OT: 1-2 50.0%	Game: 18-28 64.3%
	1st Qtr 4-5 80.0%	2nd Qtr 1-4 25.0%	3rd Qtr 4-6 66.7%	4th Qtr 8-11 72.7%

West Virginia 74 - 15-3/3-3

##	Player	g	Total		3-Ptr	Rebounds			PF	TP	A	TO	Blk	Stl	Min
			FG-FGA	FG-FGA	FT-FTA	Off	Def	Tot							
00	DAVENPORT ,NAOMI	g	5-13	4-5	3-4	2	6	8	5	17	1	3	1	4	28
11	MULDROW,T EANA	f	7-17	0-3	2-3	1	7	8	4	16	1	5	3	3	43
12	RAY,CHANIA	g	6-12	2-4	3-4	0	2	2	3	17	2	4	1	4	45
13	KING,KRISTINA	f	5-9	0-0	2-2	2	8	10	3	12	2	4	0	3	41
22	PARDEE,KATRINA	g	2-11	1-6	0-0	0	3	3	3	5	5	4	0	0	41
01	JONES,ASHLEY		2-3	1-2	0-0	1	0	1	3	5	3	1	0	0	21
03	HARDEN,DESTINY		0-0	0-0	0-0	0	0	0	0	0	0	0	0	0	0
34	EKHELAR,THEHERESA		0-0	0-0	2-2	1	1	2	0	2	0	1	0	0	6
TEAM						1	2	3	0						
TOTALS			27-65	8-20	12-15	8	29	37	21	74	14	22	5	14	225

Deadball Rebounds: 1,0

FG %	1st Half: 15-35 42.9%	2nd Half: 10-24 41.7%	OT: 2-6 33.3%	Game: 27-65 41.5%
	1st Qtr 9-21 42.9%	2nd Qtr 6-14 42.9%	3rd Qtr 6-14 42.9%	4th Qtr 4-10 40.0%
3FG %	1st Half: 4-11 36.4%	2nd Half: 4-8 50.0%	OT: 0-1 00.0%	Game: 8-20 40.0%
	1st Qtr 3-8 37.5%	2nd Qtr 1-3 33.3%	3rd Qtr 4-6 66.7%	4th Qtr 0-2 00.0%
FT %	1st Half: 7-8 87.5%	2nd Half: 3-4 75.0%	OT: 2-3 66.7%	Game: 12-15 80.0%
	1st Qtr 4-4 100.0%	2nd Qtr 3-4 75.0%	3rd Qtr 1-2 50.0%	4th Qtr 2-2 100.0%

Officials: Laura Morris, Bryan Enterline, Eric Brewton
 Technical Fouls: TCU- WOODS,JAYDE; West Virginia- DAVENPORT,NAOMI;
 Attendance: 3139

Davenport (WVU) fouled out with 8:41 remaining in the 4th quarter.
 Akomolafe (TCU) fouled out with 2:11 remaining in overtime.

Score by periods	1st	2nd	3rd	4th	5th	Total
TCU	17	12	18	21	8	76
West Virginia	25	16	17	10	6	74

Points	In Paint	Off T/O	2nd Chance	Fast Break	Bench
TCU	40	19	11	2	39
WVU	28	29	11	10	7

Last FG - TCU 5th-00:04, WVU 5th-01:09.
 Largest lead - TCU by 3 OT-03:24; West Virginia by 18 3rd-06:19
 TCU led for 3:29. WVU led for 39:11. Game was tied for 2:07.

Score tied - 4 times; Lead changed - 6 times

Official Basketball Box Score -- Game Totals -- First Half Statistics
 TCU vs West Virginia
 1/13/2018 5:00 p.m. at WVU Coliseum, Morgantown, W.Va.



TCU 29 • 12-5/3-3

##	Player	g	Total			3-Ptr			Rebounds			PF	TP	A	TO	Blk	Stl	Min
			FG-FGA	FG-FGA	FT-FTA	FG-FGA	FG-FGA	FT-FTA	Off	Def	Tot							
01	THOMPSON,TOREE	g	2-7	1-4	0-0	0	0	0	0	0	0	5	0	3	0	0	15	
15	WOODS,JAYDE	g	1-1	0-0	0-2	1	1	2	1	2	2	2	1	0	1	14		
21	COLEMAN,SYDNEY	g	0-0	0-0	0-0	0	1	1	0	0	0	0	0	0	0	4		
22	MOORE,JORDAN	c	2-7	0-0	0-0	1	0	1	2	4	1	2	0	0	0	8		
33	AKOMOLAFE,ADEOLA	f	0-1	0-0	1-2	0	1	1	2	1	1	0	0	0	5			
00	OKONKWO,AMY		1-2	0-0	0-0	0	5	5	2	2	0	3	1	1	8			
04	RAMIREZ,AMBER		0-1	0-1	2-2	0	1	1	0	2	0	1	0	1	7			
20	HEARD,LAUREN		0-0	0-0	0-0	0	1	1	0	0	1	0	0	0	5			
24	VANN,DAKOTA		0-1	0-1	0-0	0	0	0	1	0	0	2	1	1	11			
25	RAY,KIANNA		3-5	0-1	2-3	1	6	7	0	8	3	1	0	0	17			
31	HELLESSEY,ELLA		2-3	1-1	0-0	0	0	0	0	5	0	0	0	0	6			
TEAM						0	0	0	0				0					
Totals			11-28	2-8	5-9	3	16	19	8	29	8	13	2	4	100			

FG % 1st Qtr 6-17 35.3% 2nd Qtr 5-11 45.5% Half: 11-28 39.3%
 3FG % 1st Qtr 1-4 25.0% 2nd Qtr 1-4 25.0% Half: 2-8 25.0%
 FT % 1st Qtr 4-5 80.0% 2nd Qtr 1-4 25.0% Half: 5-9 55.6%

West Virginia 41 • 15-3/3-3

##	Player	g	Total			3-Ptr			Rebounds			PF	TP	A	TO	Blk	Stl	Min
			FG-FGA	FG-FGA	FT-FTA	FG-FGA	FG-FGA	FT-FTA	Off	Def	Tot							
00	DAVENPORT,NAOMI	g	3-9	2-3	3-4	1	5	6	1	11	0	0	1	2	17			
11	MULDROW,TEANA	f	4-8	0-2	0-0	0	3	3	1	8	1	3	2	2	18			
12	RAY,CHANIA	g	1-5	0-2	0-0	0	1	1	1	2	1	1	0	1	20			
13	KING,KRISTINA	f	4-6	0-0	2-2	1	5	6	2	10	1	1	0	3	18			
22	PARDEE,KATRINA	g	2-6	1-3	0-0	0	1	1	0	5	2	0	0	0	18			
01	JONES,ASHLEY		1-1	1-1	0-0	0	0	0	2	3	1	0	0	0	5			
03	HARDEN,DESTINY		0-0	0-0	0-0	0	0	0	0	0	0	0	0	0	0			
34	EKHELAR,THEHERESA		0-0	0-0	2-2	1	0	1	0	2	0	1	0	0	4			
TEAM						1	1	2	0				0					
Totals			15-35	4-11	7-8	4	16	20	7	41	6	6	3	8	100			

FG % 1st Qtr 9-21 42.9% 2nd Qtr 6-14 42.9% Half: 15-35 42.9%
 3FG % 1st Qtr 3-8 37.5% 2nd Qtr 1-3 33.3% Half: 4-11 36.4%
 FT % 1st Qtr 4-4 100.0% 2nd Qtr 3-4 75.0% Half: 7-8 87.5%

Officials: Laura Morris, Bryan Enterline, Eric Brewton
 Technical Fouls: TCU- None. West Virginia- None.
 Davenport (WVU) fouled out with 8:41 remaining in the 4th quarter.
 Akomolafe (TCU) fouled out with 2:11 remaining in overtime.

Score by periods	1st	2nd	3rd	4th	5th	Total
TCU	17	12	18	21	8	76
West Virginia	25	16	17	10	6	74

Points	In Paint	Off T/O	2nd Chance	Fast Break	Bench
TCU	14	5	0	0	17
West Virginia	18	14	7	8	5

Last FG - TCU 2nd-02:04, WVU 2nd-00:43.
 TCU led for 0:21. WVU led for 18:20. Game was tied for 1:09.

Score tied - 1 times
 Lead changed - 1 times

TCU vs West Virginia
1/13/2018; 5:00 p.m. at WVU Coliseum, Morgantown, W.Va.
Period 1 Play-By-Play



VISITORS: TCU	Time	Score	Margin	HOME: West Virginia
GOOD! LAYUP by MOORE,JORDAN [PNT]	09:46	0-2	V 2	
ASSIST by AKOMOLAFE,ADEOLA	09:46			
	09:25	2-2	T	GOOD! JUMPER by PARDEE,KATRINA
MISSED JUMPER by AKOMOLAFE,ADEOLA	08:57			
	08:57			REBOUND (DEF) by DAVENPORT,NAOMI
	08:46			MISSED 3PTR by DAVENPORT,NAOMI
REBOUND (DEF) by AKOMOLAFE,ADEOLA	08:46			
TURNOVER by THOMPSON,TOREE	08:33			
	08:32			STEAL by MULDRON,TEANA
	08:30	4-2	H 2	GOOD! LAYUP by MULDRON,TEANA [FB/PNT]
	08:15			FOUL by DAVENPORT,NAOMI
MISSED FT by AKOMOLAFE,ADEOLA	08:15			
REBOUND (DEADB) by TEAM	08:15			
GOOD! FT by AKOMOLAFE,ADEOLA	08:15	4-3	H 1	
	08:09			MISSED 3PTR by MULDRON,TEANA
REBOUND (DEF) by COLEMAN,SYDNEY	08:09			
TURNOVER by THOMPSON,TOREE	07:41			
	07:39			STEAL by KING,KRISTINA
	07:34			MISSED 3PTR by RAY,CHANIA
REBOUND (DEF) by WOODS,JAYDE	07:34			
TIMEOUT 30SEC	07:25			
SUB IN: RAMIREZ,AMBER	07:25			
SUB IN: OKONKWO,AMY	07:25			
SUB IN: RAY,KIANNA	07:25			
SUB OUT: WOODS,JAYDE	07:25			
SUB OUT: COLEMAN,SYDNEY	07:25			
SUB OUT: MOORE,JORDAN	07:25			
MISSED JUMPER by THOMPSON,TOREE	07:21			
	07:21			REBOUND (DEF) by TEAM
	07:06			MISSED JUMPER by PARDEE,KATRINA
REBOUND (DEF) by OKONKWO,AMY	07:06			
MISSED 3PTR by RAMIREZ,AMBER	06:56			
	06:56			REBOUND (DEF) by KING,KRISTINA
	06:50			MISSED 3PTR by PARDEE,KATRINA
	06:50			REBOUND (OFF) by KING,KRISTINA
FOUL by AKOMOLAFE,ADEOLA	06:35			
	06:35	5-3	H 2	GOOD! FT by KING,KRISTINA
	06:35	6-3	H 3	GOOD! FT by KING,KRISTINA
SUB IN: MOORE,JORDAN	06:35			
SUB OUT: AKOMOLAFE,ADEOLA	06:35			
MISSED JUMPER by MOORE,JORDAN	06:19			
	06:19			REBOUND (DEF) by DAVENPORT,NAOMI
	06:10			MISSED JUMPER by MULDRON,TEANA
REBOUND (DEF) by OKONKWO,AMY	06:10			
MISSED JUMPER by MOORE,JORDAN	06:01			
	06:01			BLOCK by DAVENPORT,NAOMI
	05:59			REBOUND (DEF) by DAVENPORT,NAOMI
	05:51			TURNOVER by MULDRON,TEANA
STEAL by RAMIREZ,AMBER	05:49			
MISSED 3PTR by THOMPSON,TOREE	05:45			
REBOUND (OFF) by MOORE,JORDAN	05:45			
MISSED LAYUP by MOORE,JORDAN	05:42			
	05:42			REBOUND (DEF) by RAY,CHANIA
	05:34			MISSED JUMPER by RAY,CHANIA
BLOCK by OKONKWO,AMY	05:34			
REBOUND (DEF) by OKONKWO,AMY	05:32			
	05:28			FOUL by MULDRON,TEANA
GOOD! FT by RAMIREZ,AMBER	05:28	6-4	H 2	
GOOD! FT by RAMIREZ,AMBER	05:28	6-5	H 1	
SUB IN: WOODS,JAYDE	05:28			
SUB OUT: MOORE,JORDAN	05:28			
	05:28			SUB IN: JONES,ASHLEY
	05:28			SUB OUT: DAVENPORT,NAOMI
	05:07	8-5	H 3	GOOD! JUMPER by KING,KRISTINA [PNT]
	05:01			FOUL by JONES,ASHLEY
TURNOVER by OKONKWO,AMY	04:57			
FOUL by OKONKWO,AMY	04:57			
SUB IN: COLEMAN,SYDNEY	04:57			
SUB OUT: OKONKWO,AMY	04:57			

VISITORS: TCU	Time	Score	Margin	HOME: West Virginia
	04:47	11-5	H 6	GOOD! 3PTR by PARDEE,KATRINA
	04:47			ASSIST by JONES,ASHLEY
GOOD! LAYUP by RAY,KIANNA [PNT]	04:33	11-7	H 4	
ASSIST by WOODS,JAYDE	04:33			
	04:17	13-7	H 6	GOOD! LAYUP by MULDROW,TEANA [PNT]
	04:17			ASSIST by PARDEE,KATRINA
MISSED LAYUP by THOMPSON,TOREE	04:08			
	04:08			REBOUND (DEF) by MULDROW,TEANA
	03:57	16-7	H 9	GOOD! 3PTR by JONES,ASHLEY
	03:57			ASSIST by KING,KRISTINA
TIMEOUT 30SEC	03:55			
SUB IN: VANN,DAKOTA	03:55			
SUB IN: MOORE,JORDAN	03:55			
SUB OUT: COLEMAN,SYDNEY	03:55			
SUB OUT: WOODS,JAYDE	03:55			
TURNOVER by MOORE,JORDAN	03:36			
	03:35			STEAL by RAY,CHANIA
	03:32	18-7	H 11	GOOD! LAYUP by KING,KRISTINA [FB/PNT]
	03:32			ASSIST by RAY,CHANIA
MISSED LAYUP by MOORE,JORDAN	03:16			
	03:16			BLOCK by MULDROW,TEANA
	03:14			REBOUND (DEF) by MULDROW,TEANA
SUB IN: HEARD,LAUREN	03:14			
SUB OUT: RAMIREZ,AMBER	03:14			
	03:13			TURNOVER by MULDROW,TEANA
GOOD! 3PTR by THOMPSON,TOREE	02:55	18-10	H 8	
ASSIST by MOORE,JORDAN	02:55			
	02:33			MISSED JUMPER by KING,KRISTINA
REBOUND (DEF) by RAY,KIANNA	02:33			
GOOD! LAYUP by MOORE,JORDAN [PNT]	02:24	18-12	H 6	
ASSIST by RAY,KIANNA	02:24			
	02:08			MISSED JUMPER by KING,KRISTINA
REBOUND (DEF) by HEARD,LAUREN	02:08			
MISSED JUMPER by MOORE,JORDAN	01:59			
	01:59			BLOCK by MULDROW,TEANA
	01:59			REBOUND (DEF) by MULDROW,TEANA
SUB IN: WOODS,JAYDE	01:59			
SUB OUT: THOMPSON,TOREE	01:59			
	01:59			SUB IN: EKHELAR,THERESA
	01:59			SUB IN: DAVENPORT,NAOMI
	01:59			SUB OUT: KING,KRISTINA
	01:59			SUB OUT: PARDEE,KATRINA
	01:42			MISSED JUMPER by DAVENPORT,NAOMI
	01:42			REBOUND (OFF) by EKHELAR,THERESA
FOUL by MOORE,JORDAN	01:42			
	01:42	19-12	H 7	GOOD! FT by EKHELAR,THERESA
	01:42	20-12	H 8	GOOD! FT by EKHELAR,THERESA
SUB IN: HELLESSEY,ELLA	01:42			
SUB OUT: MOORE,JORDAN	01:42			
MISSED 3PTR by VANN,DAKOTA	01:33			
	01:33			REBOUND (DEF) by DAVENPORT,NAOMI
	01:13	22-12	H 10	GOOD! LAYUP by RAY,CHANIA [PNT]
GOOD! JUMPER by HELLESSEY,ELLA	00:56	22-14	H 8	
ASSIST by RAY,KIANNA	00:56			
	00:43			MISSED JUMPER by DAVENPORT,NAOMI
	00:43			REBOUND (OFF) by DAVENPORT,NAOMI
	00:36	25-14	H 11	GOOD! 3PTR by DAVENPORT,NAOMI
	00:20			FOUL by JONES,ASHLEY
	00:20			SUB IN: PARDEE,KATRINA
	00:20			SUB OUT: JONES,ASHLEY
GOOD! LAYUP by RAY,KIANNA [PNT]	00:15	25-16	H 9	
ASSIST by WOODS,JAYDE	00:15			
	00:13			FOUL by RAY,CHANIA
GOOD! FT by RAY,KIANNA	00:13	25-17	H 8	
	00:03			MISSED 3PTR by MULDROW,TEANA
	00:03			REBOUND (OFF) by TEAM

TCU 17, West Virginia 25

Period 1-only	In Paint	Off T/O	2nd Chance	Fast Break	Bench	
TCU	8	3	0	0	9	Score tied - 0 times
WVU	10	7	7	4	5	Lead changed - 0 times

TCU vs West Virginia
1/13/2018; 5:00 p.m. at WVU Coliseum, Morgantown, W.Va.
Period 2 Play-By-Play



VISITORS: TCU	Time	Score	Margin	HOME: West Virginia
SUB IN: RAMIREZ,AMBER	10:00			
SUB IN: OKONKWO,AMY	10:00			
SUB IN: RAY,KIANNA	10:00			
SUB OUT: COLEMAN,SYDNEY	10:00			
SUB OUT: MOORE,JORDAN	10:00			
SUB OUT: AKOMOLAFE,ADEOLA	10:00			
	10:00			SUB IN: JONES,ASHLEY
MISSED JUMPER by OKONKWO,AMY	09:48			
REBOUND (OFF) by WOODS,JAYDE	09:48			
MISSED 3PTR by THOMPSON,TOREE	09:42			
	09:42			REBOUND (DEF) by KING,KRISTINA
	09:25			MISSED 3PTR by RAY,CHANIA
REBOUND (DEF) by OKONKWO,AMY	09:25			
TURNOVER by RAMIREZ,AMBER	09:15			
	09:14			STEAL by MULDRON,TEANA
	09:12	27-17	H 10	GOOD! LAYUP by MULDRON,TEANA [FB/PNT]
GOOD! LAYUP by OKONKWO,AMY [PNT]	08:49	27-19	H 8	
	08:34			MISSED JUMPER by DAVENPORT,NAOMI
REBOUND (DEF) by RAMIREZ,AMBER	08:34			
GOOD! LAYUP by WOODS,JAYDE [PNT]	08:23	27-21	H 6	
	08:02			TURNOVER by MULDRON,TEANA
STEAL by WOODS,JAYDE	08:01			
SUB IN: AKOMOLAFE,ADEOLA	07:49			
SUB OUT: RAMIREZ,AMBER	07:49			
	07:49			SUB IN: EKHELAR,THERESA
	07:49			SUB OUT: MULDRON,TEANA
GOOD! LAYUP by THOMPSON,TOREE [PNT]	07:47	27-23	H 4	
ASSIST by RAY,KIANNA	07:47			
	07:30			MISSED 3PTR by PARDEE,KATRINA
REBOUND (DEF) by RAY,KIANNA	07:30			
TURNOVER by THOMPSON,TOREE	07:11			
SUB IN: VANN,DAKOTA	07:09			
SUB OUT: WOODS,JAYDE	07:09			
	07:00			TURNOVER by EKHELAR,THERESA
SUB IN: MOORE,JORDAN	07:00			
SUB OUT: OKONKWO,AMY	07:00			
MISSED JUMPER by RAY,KIANNA	06:34			
	06:34			REBOUND (DEF) by PARDEE,KATRINA
	06:26			TURNOVER by RAY,CHANIA
STEAL by VANN,DAKOTA	06:24			
MISSED 3PTR by THOMPSON,TOREE	06:16			
	06:16			REBOUND (DEF) by DAVENPORT,NAOMI
	05:51	29-23	H 6	GOOD! JUMPER by DAVENPORT,NAOMI
TURNOVER by VANN,DAKOTA	05:34			
	05:32			STEAL by DAVENPORT,NAOMI
FOUL by AKOMOLAFE,ADEOLA	05:29			
	05:29			MISSED FT by DAVENPORT,NAOMI
	05:29			REBOUND (DEADB) by TEAM
	05:29	30-23	H 7	GOOD! FT by DAVENPORT,NAOMI
SUB IN: OKONKWO,AMY	05:29			
SUB IN: HEARD,LAUREN	05:29			
SUB OUT: THOMPSON,TOREE	05:29			
SUB OUT: AKOMOLAFE,ADEOLA	05:29			
	05:29			SUB IN: MULDRON,TEANA
	05:29			SUB OUT: EKHELAR,THERESA
TURNOVER by VANN,DAKOTA	05:21			
	05:18			STEAL by KING,KRISTINA
	05:17			MISSED JUMPER by RAY,CHANIA
REBOUND (DEF) by RAY,KIANNA	05:17			
TURNOVER by MOORE,JORDAN	05:10			
FOUL by MOORE,JORDAN	05:10			
SUB IN: WOODS,JAYDE	05:10			
SUB OUT: MOORE,JORDAN	05:10			
	04:50			TURNOVER by KING,KRISTINA
STEAL by OKONKWO,AMY	04:49			
TURNOVER by OKONKWO,AMY	04:47			
	04:47			STEAL by DAVENPORT,NAOMI
	04:39			MISSED LAYUP by DAVENPORT,NAOMI
REBOUND (DEF) by OKONKWO,AMY	04:39			

VISITORS: TCU	Time	Score	Margin	HOME: West Virginia
TURNOVER by OKONKWO,AMY	04:18			
FOUL by OKONKWO,AMY	04:18			
	04:18			TIMEOUT MEDIA
SUB IN: HELLESSEY,ELLA	04:18			
SUB OUT: OKONKWO,AMY	04:18			
	03:59	32-23	H 9	GOOD! LAYUP by KING,KRISTINA [PNT]
	03:59			ASSIST by MULDROW,TEANA
GOOD! 3PTR by HELLESSEY,ELLA	03:45	32-26	H 6	
ASSIST by HEARD,LAUREN	03:45			
	03:34	35-26	H 9	GOOD! 3PTR by DAVENPORT,NAOMI
TURNOVER by WOODS,JAYDE	03:12			
FOUL by WOODS,JAYDE	03:12			
SUB IN: THOMPSON,TOREE	03:12			
SUB OUT: HEARD,LAUREN	03:12			
	02:50			MISSED JUMPER by MULDROW,TEANA
REBOUND (DEF) by RAY,KIANNA	02:50			
	02:32			FOUL by KING,KRISTINA
MISSED FT by WOODS,JAYDE	02:32			
REBOUND (DEADB) by TEAM	02:32			
MISSED FT by WOODS,JAYDE	02:32			
REBOUND (OFF) by RAY,KIANNA	02:32			
MISSED 3PTR by RAY,KIANNA	02:27			
	02:27			REBOUND (DEF) by KING,KRISTINA
	02:18			MISSED JUMPER by PARDEE,KATRINA
BLOCK by VANN,DAKOTA	02:18			
REBOUND (DEF) by RAY,KIANNA	02:15			
GOOD! JUMPER by RAY,KIANNA	02:04	35-28	H 7	
	01:43			MISSED LAYUP by DAVENPORT,NAOMI
REBOUND (DEF) by RAY,KIANNA	01:43			
MISSED JUMPER by HELLESSEY,ELLA	01:17			
	01:17			REBOUND (DEF) by KING,KRISTINA
	01:07	37-28	H 9	GOOD! LAYUP by MULDROW,TEANA [PNT]
	01:07			ASSIST by PARDEE,KATRINA
TURNOVER by RAY,KIANNA	00:48			
	00:46			STEAL by KING,KRISTINA
	00:43	39-28	H 11	GOOD! LAYUP by KING,KRISTINA [FB/PNT]
	00:20			FOUL by KING,KRISTINA
GOOD! FT by RAY,KIANNA	00:20	39-29	H 10	
MISSED FT by RAY,KIANNA	00:20			
	00:20			REBOUND (DEF) by KING,KRISTINA
SUB IN: RAMIREZ,AMBER	00:20			
SUB OUT: THOMPSON,TOREE	00:20			
FOUL by VANN,DAKOTA	00:03			
	00:03	40-29	H 11	GOOD! FT by DAVENPORT,NAOMI
	00:03	41-29	H 12	GOOD! FT by DAVENPORT,NAOMI
SUB IN: AKOMOLAFE,ADEOLA	00:03			
SUB OUT: RAY,KIANNA	00:03			
	00:03			SUB IN: HARDEN,DESTINY
	00:03			SUB OUT: KING,KRISTINA

TCU 29, West Virginia 41

Period 2-only	In Paint	Off T/O	2nd Chance	Fast Break	Bench	
TCU	6	2	0	0	8	Score tied - 0 times
WVU	8	7	0	4	0	Lead changed - 0 times

Official Basketball Box Score -- Game Totals -- Second Half Statistics
 TCU vs West Virginia
 1/13/2018 5:00 p.m. at WVU Coliseum, Morgantown, W.Va.



TCU 39 • 12-5/3-3

##	Player		Total			3-Ptr			Rebounds			PF	TP	A	TO	Blk	Stl	Min
			FG-FGA	FG-FGA	FT-FTA	FG-FGA	FG-FGA	FT-FTA	Off	Def	Tot							
01	THOMPSON,TOREE	g	2-6	1-2	2-2	0	1	1	1	7	0	0	0	0	0	0	15	
15	WOODS,JAYDE	g	0-3	0-0	1-2	2	0	2	2	1	2	2	1	0	0	11		
21	COLEMAN,SYDNEY	g	0-1	0-1	0-0	0	0	0	0	0	0	1	0	0	2			
22	MOORE,JORDAN	c	4-5	0-0	3-4	4	5	9	1	11	0	1	0	0	12			
33	AKOMOLAFE,ADEOLA	f	1-2	0-0	0-0	1	0	1	2	2	0	1	0	1	13			
00	OKONKWO,AMY		4-7	0-0	3-3	4	1	5	0	11	0	0	0	2	13			
04	RAMIREZ,AMBER		1-4	0-2	1-2	0	0	0	0	3	0	0	0	2	8			
20	HEARD,LAUREN		1-4	0-1	1-2	1	0	1	0	3	0	1	0	1	8			
24	VANN,DAKOTA		0-0	0-0	0-0	0	0	0	0	0	0	0	0	0	2			
25	RAY,KIANNA		0-2	0-1	1-2	1	3	4	2	1	1	2	0	3	16			
31	HELLESSEY,ELLA		0-0	0-0	0-0	0	0	0	0	0	0	0	0	0	0			
TEAM						0	2	2	0									
Totals			13-34	1-7	12-17	13	12	25	8	39	3	8	1	9	100			
FG %	3rd Qtr	7-17	41.2%	4th Qtr	6-17	35.3%	Half:	13-34	38.2%									
3FG %	3rd Qtr	0-5	00.0%	4th Qtr	1-2	50.0%	Half:	1-7	25.0%									
FT %	3rd Qtr	4-6	66.7%	4th Qtr	8-11	72.7%	Half:	12-17	70.6%									

West Virginia 27 • 15-3/3-3

##	Player		Total			3-Ptr			Rebounds			PF	TP	A	TO	Blk	Stl	Min
			FG-FGA	FG-FGA	FT-FTA	FG-FGA	FG-FGA	FT-FTA	Off	Def	Tot							
00	DAVENPORT,NAOMI	g	2-4	2-2	0-0	1	1	2	4	6	1	3	0	2	11			
11	MULDROW,TEANA	f	2-7	0-1	0-0	1	2	3	2	4	0	0	1	1	20			
12	RAY,CHANIA	g	4-6	2-2	3-4	0	1	1	2	13	0	3	1	3	20			
13	KING,KRISTINA	f	1-2	0-0	0-0	0	2	2	0	2	1	2	0	0	18			
22	PARDEE,KATRINA	g	0-3	0-2	0-0	0	2	2	3	0	3	4	0	0	18			
01	JONES,ASHLEY		1-2	0-1	0-0	1	0	1	1	2	2	0	0	0	11			
03	HARDEN,DESTINY		0-0	0-0	0-0	0	0	0	0	0	0	0	0	0	0			
34	EKHELAR,THEHERESA		0-0	0-0	0-0	0	1	1	0	0	0	0	0	0	2			
TEAM						0	1	1	0									
Totals			10-24	4-8	3-4	3	10	13	12	27	7	12	2	6	100			
FG %	3rd Qtr	6-14	42.9%	4th Qtr	4-10	40.0%	Half:	10-24	41.7%									
3FG %	3rd Qtr	4-6	66.7%	4th Qtr	0-2	00.0%	Half:	4-8	36.4%									
FT %	3rd Qtr	1-2	50.0%	4th Qtr	2-2	100.0%	Half:	3-4	75.0%									

Officials: Laura Morris, Bryan Enterline, Eric Brewton
 Technical Fouls: TCU- WOODS,JAYDE; West Virginia- DAVENPORT,NAOMI;
 Davenport (WVU) fouled out with 8:41 remaining in the 4th quarter.
 Akomolafe (TCU) fouled out with 2:11 remaining in overtime.

Score by periods	1st	2nd	3rd	4th	5th	Total
TCU	17	12	18	21	8	76
West Virginia	25	16	17	10	6	74

Points	In Paint	Off T/O	2nd Chance	Fast Break	Bench
TCU	22	11	9	2	18
West Virginia	8	11	2	2	2

Last FG - TCU 4th-00:05, WVU 4th-00:31.
 TCU led for 0:00. WVU led for 19:30. Game was tied for 0:27.

Score tied - 3 times
 Lead changed - 0 times

TCU vs West Virginia
1/13/2018; 5:00 p.m. at WVU Coliseum, Morgantown, W.Va.
Period 3 Play-By-Play



VISITORS: TCU	Time	Score	Margin	HOME: West Virginia
	09:50			MISSED JUMPER by MULDROW,TEANA
REBOUND (DEF) by MOORE,JORDAN	09:50			
TURNOVER by MOORE,JORDAN	09:36			
	09:35			STEAL by RAY,CHANIA
	09:28			MISSED JUMPER by MULDROW,TEANA
REBOUND (DEF) by THOMPSON,TOREE	09:28			
GOOD! LAYUP by MOORE,JORDAN [PNT]	09:16	41-31	H 10	
ASSIST by WOODS,JAYDE	09:16			
	08:50			MISSED JUMPER by DAVENPORT,NAOMI
REBOUND (DEF) by TEAM	08:50			
MISSED 3PTR by COLEMAN,SYDNEY	08:23			
REBOUND (OFF) by MOORE,JORDAN	08:23			
TURNOVER by COLEMAN,SYDNEY	08:07			
	07:49	44-31	H 13	GOOD! 3PTR by DAVENPORT,NAOMI
	07:49			ASSIST by PARDEE,KATRINA
TURNOVER by WOODS,JAYDE	07:36			
	07:36			STEAL by DAVENPORT,NAOMI
FOUL by WOODS,JAYDE	07:36			
SUB IN: RAY,KIANNA	07:36			
SUB IN: RAMIREZ,AMBER	07:36			
SUB OUT: WOODS,JAYDE	07:36			
SUB OUT: COLEMAN,SYDNEY	07:36			
	07:22			MISSED LAYUP by DAVENPORT,NAOMI
	07:22			REBOUND (OFF) by DAVENPORT,NAOMI
	07:19	46-31	H 15	GOOD! JUMPER by MULDROW,TEANA
MISSED 3PTR by THOMPSON,TOREE	07:06			
	07:06			REBOUND (DEF) by MULDROW,TEANA
	06:56			TURNOVER by RAY,CHANIA
STEAL by RAMIREZ,AMBER	06:55			
MISSED LAYUP by THOMPSON,TOREE	06:50			
	06:50			BLOCK by RAY,CHANIA
REBOUND (OFF) by RAY,KIANNA	06:49			
TURNOVER by AKOMOLAFE,ADEOLA	06:45			
	06:42			STEAL by DAVENPORT,NAOMI
	06:19	49-31	H 18	GOOD! 3PTR by RAY,CHANIA
	06:19			ASSIST by DAVENPORT,NAOMI
GOOD! LAYUP by THOMPSON,TOREE [PNT]	05:51	49-33	H 16	
	05:44			MISSED JUMPER by RAY,CHANIA
REBOUND (DEF) by RAY,KIANNA	05:44			
MISSED LAYUP by MOORE,JORDAN	05:33			
REBOUND (OFF) by MOORE,JORDAN	05:33			
	05:32			FOUL by DAVENPORT,NAOMI
MISSED FT by MOORE,JORDAN	05:32			
REBOUND (DEADB) by TEAM	05:32			
GOOD! FT by MOORE,JORDAN	05:32	49-34	H 15	
	05:32			TURNOVER by DAVENPORT,NAOMI
STEAL by AKOMOLAFE,ADEOLA	05:32			
SUB IN: OKONKWO,AMY	05:32			
SUB IN: HEARD,LAUREN	05:32			
SUB OUT: THOMPSON,TOREE	05:32			
SUB OUT: MOORE,JORDAN	05:32			
	05:32			SUB IN: EKHELAR,THERESA
	05:32			SUB OUT: KING,KRISTINA
MISSED 3PTR by RAMIREZ,AMBER	05:06			
REBOUND (OFF) by HEARD,LAUREN	05:06			
MISSED LAYUP by HEARD,LAUREN	05:01			
REBOUND (OFF) by OKONKWO,AMY	05:01			
TIMEOUT MEDIA	04:58			
MISSED 3PTR by RAY,KIANNA	04:54			
	04:54			REBOUND (DEF) by EKHELAR,THERESA
	04:41			TURNOVER by PARDEE,KATRINA
STEAL by RAMIREZ,AMBER	04:39			
	04:37			FOUL by RAY,CHANIA
MISSED FT by HEARD,LAUREN	04:37			
REBOUND (DEADB) by TEAM	04:37			
GOOD! FT by HEARD,LAUREN	04:37	49-35	H 14	
	04:37			SUB IN: JONES,ASHLEY
	04:37			SUB OUT: PARDEE,KATRINA
FOUL by RAY,KIANNA	04:22			

VISITORS: TCU	Time	Score	Margin	HOME: West Virginia
	04:22			SUB IN: KING,KRISTINA
	04:22			SUB OUT: EKHELAR,THERESA
	03:56			MISSED 3PTR by JONES,ASHLEY
	03:56			REBOUND (OFF) by MULDROW,TEANA
	03:53			MISSED LAYUP by MULDROW,TEANA
REBOUND (DEF) by TEAM	03:53			
GOOD! JUMPER by OKONKWO,AMY [PNT]	03:33	49-37	H 12	
	03:23	52-37	H 15	GOOD! 3PTR by DAVENPORT,NAOMI
	03:23			ASSIST by JONES,ASHLEY
GOOD! LAYUP by OKONKWO,AMY [PNT]	02:58	52-39	H 13	
	02:58			FOUL by MULDROW,TEANA
GOOD! FT by OKONKWO,AMY	02:57	52-40	H 12	
SUB IN: MOORE,JORDAN	02:57			
SUB OUT: AKOMOLAFE,ADEOLA	02:57			
	02:32			TURNOVER by RAY,CHANIA
STEAL by RAY,KIANNA	02:31			
MISSED JUMPER by RAMIREZ,AMBER	02:29			
	02:29			REBOUND (DEF) by TEAM
SUB IN: THOMPSON,TOREE	02:27			
SUB OUT: RAMIREZ,AMBER	02:27			
	02:27			SUB IN: PARDEE,KATRINA
	02:27			SUB OUT: JONES,ASHLEY
	02:07	54-40	H 14	GOOD! JUMPER by MULDROW,TEANA
	02:07			ASSIST by KING,KRISTINA
GOOD! LAYUP by MOORE,JORDAN [PNT]	01:37	54-42	H 12	
	01:37			FOUL by DAVENPORT,NAOMI
GOOD! FT by MOORE,JORDAN	01:37	54-43	H 11	
	01:37			TURNOVER by KING,KRISTINA
SUB IN: VANN,DAKOTA	01:37			
SUB IN: WOODS,JAYDE	01:37			
SUB OUT: OKONKWO,AMY	01:37			
SUB OUT: RAY,KIANNA	01:37			
STEAL by HEARD,LAUREN	01:35			
GOOD! LAYUP by HEARD,LAUREN [FB/PNT]	01:33	54-45	H 9	
	01:22			MISSED 3PTR by PARDEE,KATRINA
REBOUND (DEF) by MOORE,JORDAN	01:22			
TURNOVER by HEARD,LAUREN	01:14			
	01:11			STEAL by RAY,CHANIA
FOUL by MOORE,JORDAN	01:00			
	01:00	55-45	H 10	GOOD! FT by RAY,CHANIA
	01:00			MISSED FT by RAY,CHANIA
REBOUND (DEF) by MOORE,JORDAN	01:00			
MISSED JUMPER by THOMPSON,TOREE	00:44			
REBOUND (OFF) by MOORE,JORDAN	00:44			
GOOD! LAYUP by MOORE,JORDAN [PNT]	00:42	55-47	H 8	
	00:30	58-47	H 11	GOOD! 3PTR by RAY,CHANIA
	00:30			ASSIST by PARDEE,KATRINA
MISSED 3PTR by HEARD,LAUREN	00:04			
	00:04			BLOCK by MULDROW,TEANA
	00:00			REBOUND (DEF) by KING,KRISTINA

TCU 76, West Virginia 74

Period 3-only	In Paint	Off T/O	2nd Chance	Fast Break	Bench	
TCU	14	3	3	2	8	Score tied - 0 times
WVU	0	9	2	0	0	Lead changed - 0 times

TCU vs West Virginia
1/13/2018; 5:00 p.m. at WVU Coliseum, Morgantown, W.Va.
Period 4 Play-By-Play



VISITORS: TCU	Time	Score	Margin	HOME: West Virginia
SUB IN: OKONKWO,AMY	10:00			
SUB IN: RAY,KIANNA	10:00			
SUB OUT: COLEMAN,SYDNEY	10:00			
SUB OUT: MOORE,JORDAN	10:00			
MISSED LAYUP by WOODS,JAYDE	09:47			
REBOUND (OFF) by AKOMOLAFE,ADEOLA	09:47			
GOOD! 3PTR by THOMPSON,TOREE	09:41	58-50	H 8	
	09:17			TURNOVER by KING,KRISTINA
STEAL by RAY,KIANNA	09:16			
TURNOVER by RAY,KIANNA	09:12			
FOUL by RAY,KIANNA	09:12			
	09:12			SUB IN: EKHELAR,THERESA
	09:12			SUB OUT: KING,KRISTINA
	08:46			TURNOVER by DAVENPORT,NAOMI
STEAL by RAY,KIANNA	08:46			
MISSED LAYUP by WOODS,JAYDE	08:42			
	08:42			REBOUND (DEF) by DAVENPORT,NAOMI
	08:41			FOUL by DAVENPORT,NAOMI
FOUL (TECH) by WOODS,JAYDE	08:41			
	08:41			FOUL (TECH) by DAVENPORT,NAOMI
FOUL by WOODS,JAYDE	08:41			
	08:41			FOUL by DAVENPORT,NAOMI
GOOD! FT by WOODS,JAYDE	08:41	58-51	H 7	
MISSED FT by WOODS,JAYDE	08:41			
	08:41			REBOUND (DEF) by PARDEE,KATRINA
	08:41			SUB IN: JONES,ASHLEY
	08:41			SUB OUT: DAVENPORT,NAOMI
	08:39			TURNOVER by DAVENPORT,NAOMI
STEAL by OKONKWO,AMY	08:38			
FOUL by AKOMOLAFE,ADEOLA	08:14			
	07:53			TURNOVER by PARDEE,KATRINA
STEAL by OKONKWO,AMY	07:51			
	07:43			FOUL by PARDEE,KATRINA
GOOD! FT by RAY,KIANNA	07:43	58-52	H 6	
MISSED FT by RAY,KIANNA	07:43			
	07:43			REBOUND (DEF) by PARDEE,KATRINA
SUB IN: MOORE,JORDAN	07:43			
SUB OUT: AKOMOLAFE,ADEOLA	07:43			
	07:43			SUB IN: KING,KRISTINA
	07:43			SUB OUT: EKHELAR,THERESA
	07:34			TURNOVER by PARDEE,KATRINA
	07:31			TIMEOUT 30SEC
MISSED JUMPER by THOMPSON,TOREE	07:13			
REBOUND (OFF) by WOODS,JAYDE	07:13			
MISSED JUMPER by OKONKWO,AMY	07:00			
	07:00			REBOUND (DEF) by KING,KRISTINA
	06:43	60-52	H 8	GOOD! LAYUP by KING,KRISTINA [PNT]
	06:43			ASSIST by JONES,ASHLEY
MISSED JUMPER by RAY,KIANNA	06:29			
REBOUND (OFF) by OKONKWO,AMY	06:29			
MISSED JUMPER by OKONKWO,AMY	06:24			
	06:24			REBOUND (DEF) by MULDROW,TEANA
	05:55			MISSED JUMPER by PARDEE,KATRINA
BLOCK by WOODS,JAYDE	05:55			
REBOUND (DEF) by OKONKWO,AMY	05:54			
TURNOVER by WOODS,JAYDE	05:39			
	05:38			STEAL by MULDROW,TEANA
SUB IN: RAMIREZ,AMBER	05:30			
SUB OUT: WOODS,JAYDE	05:30			
	05:25			MISSED LAYUP by KING,KRISTINA
REBOUND (DEF) by MOORE,JORDAN	05:25			
SUB IN: AKOMOLAFE,ADEOLA	05:19			
SUB OUT: MOORE,JORDAN	05:19			
GOOD! LAYUP by OKONKWO,AMY [PNT]	05:09	60-54	H 6	
	04:51	62-54	H 8	GOOD! JUMPER by RAY,CHANIA [PNT]
TURNOVER by RAY,KIANNA	04:44			
	04:42			STEAL by RAY,CHANIA
	04:39	64-54	H 10	GOOD! LAYUP by RAY,CHANIA [FB/PNT]
	04:39			ASSIST by PARDEE,KATRINA

VISITORS: TCU	Time	Score	Margin	HOME: West Virginia
MISSED LAYUP by OKONKWO,AMY	04:15			
	04:15			REBOUND (DEF) by RAY,CHANIA
	03:49			TIMEOUT media
SUB IN: HEARD,LAUREN	03:49			
SUB OUT: THOMPSON,TOREE	03:49			
	03:47			MISSED 3PTR by MULDROW,TEANA
REBOUND (DEF) by RAY,KIANNA	03:47			
	03:36			FOUL by RAY,CHANIA
GOOD! FT by OKONKWO,AMY	03:36	64-55	H 9	
GOOD! FT by OKONKWO,AMY	03:36	64-56	H 8	
SUB IN: WOODS,JAYDE	03:36			
SUB OUT: RAMIREZ,AMBER	03:36			
MISSED LAYUP by HEARD,LAUREN	03:12			
REBOUND (OFF) by OKONKWO,AMY	03:12			
MISSED JUMPER by AKOMOLAFE,ADEOLA	03:05			
REBOUND (OFF) by OKONKWO,AMY	03:05			
	02:59			TURNOVER by RAY,CHANIA
SUB IN: MOORE,JORDAN	02:59			
SUB IN: RAMIREZ,AMBER	02:59			
SUB OUT: HEARD,LAUREN	02:59			
SUB OUT: AKOMOLAFE,ADEOLA	02:59			
GOOD! JUMPER by AKOMOLAFE,ADEOLA	02:56	64-58	H 6	
GOOD! LAYUP by MOORE,JORDAN [PNT]	02:47	64-60	H 4	
ASSIST by WOODS,JAYDE	02:47			
	02:47			FOUL by PARDEE,KATRINA
GOOD! FT by MOORE,JORDAN	02:47	64-61	H 3	
SUB IN: AKOMOLAFE,ADEOLA	02:47			
SUB IN: THOMPSON,TOREE	02:47			
SUB OUT: OKONKWO,AMY	02:47			
SUB OUT: RAMIREZ,AMBER	02:47			
	02:24			MISSED JUMPER by MULDROW,TEANA
REBOUND (DEF) by MOORE,JORDAN	02:24			
MISSED LAYUP by WOODS,JAYDE	02:01			
REBOUND (OFF) by WOODS,JAYDE	02:01			
SUB IN: RAMIREZ,AMBER	01:59			
SUB IN: OKONKWO,AMY	01:59			
SUB OUT: WOODS,JAYDE	01:59			
SUB OUT: AKOMOLAFE,ADEOLA	01:59			
	01:55			FOUL by MULDROW,TEANA
GOOD! FT by THOMPSON,TOREE	01:55	64-62	H 2	
GOOD! FT by THOMPSON,TOREE	01:55	64-63	H 1	
SUB IN: HEARD,LAUREN	01:55			
SUB IN: AKOMOLAFE,ADEOLA	01:55			
SUB OUT: RAMIREZ,AMBER	01:55			
SUB OUT: OKONKWO,AMY	01:55			
FOUL by AKOMOLAFE,ADEOLA	01:42			
SUB IN: OKONKWO,AMY	01:42			
SUB IN: RAMIREZ,AMBER	01:42			
SUB OUT: AKOMOLAFE,ADEOLA	01:42			
SUB OUT: THOMPSON,TOREE	01:42			
	01:36			MISSED 3PTR by PARDEE,KATRINA
	01:36			REBOUND (OFF) by JONES,ASHLEY
	01:31			MISSED LAYUP by RAY,CHANIA
REBOUND (DEF) by RAY,KIANNA	01:31			
MISSED 3PTR by RAMIREZ,AMBER	01:06			
REBOUND (OFF) by MOORE,JORDAN	01:06			
	00:50			FOUL by JONES,ASHLEY
MISSED FT by RAMIREZ,AMBER	00:50			
REBOUND (DEADB) by TEAM	00:50			
GOOD! FT by RAMIREZ,AMBER	00:50	64-64	T	
	00:50			TIMEOUT 30SEC
SUB IN: THOMPSON,TOREE	00:50			
SUB IN: WOODS,JAYDE	00:50			
SUB IN: AKOMOLAFE,ADEOLA	00:50			
SUB OUT: MOORE,JORDAN	00:50			
SUB OUT: OKONKWO,AMY	00:50			
SUB OUT: RAMIREZ,AMBER	00:50			
	00:46			TIMEOUT 30SEC
	00:31	66-64	H 2	GOOD! JUMPER by JONES,ASHLEY [PNT]
TIMEOUT 30SEC	00:30			
SUB IN: MOORE,JORDAN	00:30			
SUB IN: RAMIREZ,AMBER	00:30			
SUB IN: OKONKWO,AMY	00:30			
SUB OUT: HEARD,LAUREN	00:30			
SUB OUT: WOODS,JAYDE	00:30			

VISITORS: TCU	Time	Score	Margin	HOME: West Virginia
SUB OUT: AKOMOLAFE,ADEOLA	00:30			
GOOD! LAYUP by RAMIREZ,AMBER [PNT]	00:08	66-66	T	
	09:50			FOUL by PARDEE,KATRINA
SUB IN: AKOMOLAFE,ADEOLA	00:08			
SUB IN: WOODS,JAYDE	00:08			
SUB IN: HEARD,LAUREN	00:08			
SUB OUT: MOORE,JORDAN	00:08			
SUB OUT: RAMIREZ,AMBER	00:08			
SUB OUT: OKONKWO,AMY	00:08			
FOUL by THOMPSON,TOREE	00:05			
	00:05	67-66	H 1	GOOD! FT by RAY,CHANIA
	00:05	68-66	H 2	GOOD! FT by RAY,CHANIA
TIMEOUT TEAM	00:05			
	03:21			TURNOVER by PARDEE,KATRINA
GOOD! LAYUP by OKONKWO,AMY [PNT]	00:05	68-68	T	
SUB IN: RAMIREZ,AMBER	00:05			
SUB IN: MOORE,JORDAN	00:05			
SUB IN: OKONKWO,AMY	00:05			
SUB OUT: AKOMOLAFE,ADEOLA	00:05			
SUB OUT: WOODS,JAYDE	00:05			
SUB OUT: HEARD,LAUREN	00:05			
ASSIST by RAY,KIANNA	00:02			

TCU 76, West Virginia 74

Period 4-only	In Paint	Off T/O	2nd Chance	Fast Break	Bench	
TCU	8	8	6	0	10	Score tied - 6 times
WVU	8	2	0	2	2	Lead changed - 0 times

TCU vs West Virginia
1/13/2018; 5:00 p.m. at WVU Coliseum, Morgantown, W.Va.
Period 5 Play-By-Play



VISITORS: TCU	Time	Score	Margin	HOME: West Virginia
SUB IN: HEARD,LAUREN	05:00			
SUB IN: RAY,KIANNA	05:00			
SUB OUT: WOODS,JAYDE	05:00			
SUB OUT: COLEMAN,SYDNEY	05:00			
	05:00			SUB IN: JONES,ASHLEY
	05:00			SUB OUT: DAVENPORT,NAOMI
MISSED JUMPER by RAY,KIANNA	04:34			
REBOUND (OFF) by MOORE,JORDAN	04:34			
GOOD! LAYUP by MOORE,JORDAN [PNT]	04:29	68-70	V 2	
	04:20			TURNOVER by MULDROW,TEANA
	04:20			FOUL by MULDROW,TEANA
SUB IN: OKONKWO,AMY	04:20			
SUB IN: RAMIREZ,AMBER	04:20			
SUB OUT: HEARD,LAUREN	04:20			
SUB OUT: AKOMOLAFE,ADEOLA	04:20			
MISSED JUMPER by OKONKWO,AMY	04:13			
	04:13			REBOUND (DEF) by KING,KRISTINA
	03:49			MISSED JUMPER by KING,KRISTINA
REBOUND (DEF) by OKONKWO,AMY	03:49			
	03:24			FOUL by KING,KRISTINA
MISSED FT by RAMIREZ,AMBER	03:24			
REBOUND (DEADB) by TEAM	03:24			
GOOD! FT by RAMIREZ,AMBER	03:24	68-71	V 3	
SUB IN: HEARD,LAUREN	03:24			
SUB IN: AKOMOLAFE,ADEOLA	03:24			
SUB OUT: OKONKWO,AMY	03:24			
SUB OUT: RAMIREZ,AMBER	03:24			
	03:12			TURNOVER by JONES,ASHLEY
SUB IN: RAMIREZ,AMBER	03:12			
SUB IN: OKONKWO,AMY	03:12			
SUB OUT: HEARD,LAUREN	03:12			
SUB OUT: AKOMOLAFE,ADEOLA	03:12			
TURNOVER by RAMIREZ,AMBER	02:58			
FOUL by RAMIREZ,AMBER	02:58			
SUB IN: HEARD,LAUREN	02:58			
SUB IN: AKOMOLAFE,ADEOLA	02:58			
SUB OUT: RAMIREZ,AMBER	02:58			
SUB OUT: OKONKWO,AMY	02:58			
	02:46			MISSED JUMPER by MULDROW,TEANA
REBOUND (DEF) by TEAM	02:46			
SUB IN: RAMIREZ,AMBER	02:43			
SUB IN: OKONKWO,AMY	02:43			
SUB OUT: HEARD,LAUREN	02:43			
SUB OUT: AKOMOLAFE,ADEOLA	02:43			
TURNOVER by RAY,KIANNA	02:25			
SUB IN: AKOMOLAFE,ADEOLA	02:25			
SUB IN: HEARD,LAUREN	02:25			
SUB OUT: RAMIREZ,AMBER	02:25			
SUB OUT: OKONKWO,AMY	02:25			
FOUL by AKOMOLAFE,ADEOLA	02:11			
	02:11	69-71	V 2	GOOD! FT by MULDROW,TEANA
	02:11	70-71	V 1	GOOD! FT by MULDROW,TEANA
SUB IN: RAMIREZ,AMBER	02:11			
SUB IN: OKONKWO,AMY	02:11			
SUB OUT: AKOMOLAFE,ADEOLA	02:11			
SUB OUT: HEARD,LAUREN	02:11			
TURNOVER by RAMIREZ,AMBER	02:00			
SUB IN: HEARD,LAUREN	02:00			
SUB IN: WOODS,JAYDE	02:00			
SUB OUT: RAMIREZ,AMBER	02:00			
SUB OUT: MOORE,JORDAN	02:00			
	01:51	72-71	H 1	GOOD! LAYUP by MULDROW,TEANA [PNT]
	01:51			ASSIST by RAY,CHANIA
FOUL by WOODS,JAYDE	01:51			
	01:51			MISSED FT by MULDROW,TEANA
REBOUND (DEF) by OKONKWO,AMY	01:51			
SUB IN: MOORE,JORDAN	01:51			
SUB OUT: HEARD,LAUREN	01:51			
GOOD! LAYUP by THOMPSON,TOREE [PNT]	01:35	72-73	V 1	

VISITORS: TCU	Time	Score	Margin	HOME: West Virginia
	01:09	74-73	H 1	GOOD! JUMPER by RAY,CHANIA
MISSED LAYUP by THOMPSON,TOREE	00:51			
	00:51			REBOUND (DEF) by MULDROW,TEANA
SUB IN: HEARD,LAUREN	00:48			
SUB OUT: OKONKWO,AMY	00:48			
	00:31			MISSED LAYUP by PARDEE,KATRINA
	00:31			REBOUND (OFF) by KING,KRISTINA
	00:27			TURNOVER by KING,KRISTINA
STEAL by HEARD,LAUREN	00:26			
TIMEOUT 30SEC	00:22			
SUB IN: RAMIREZ,AMBER	00:22			
SUB IN: OKONKWO,AMY	00:22			
SUB OUT: WOODS,JAYDE	00:22			
SUB OUT: HEARD,LAUREN	00:22			
MISSED LAYUP by THOMPSON,TOREE	00:09			
	00:09			REBOUND (DEF) by MULDROW,TEANA
	00:06			TURNOVER by MULDROW,TEANA
STEAL by OKONKWO,AMY	00:06			
GOOD! 3PTR by OKONKWO,AMY	00:04	74-76	V 2	
ASSIST by RAMIREZ,AMBER	00:00			
	00:00			MISSED 3PTR by PARDEE,KATRINA
REBOUND (DEF) by TEAM	00:00			

TCU 76, West Virginia 74

Period 5-only	In Paint	Off T/O	2nd Chance	Fast Break	Bench	
TCU	4	3	2	0	4	Score tied - 0 times
WVU	2	4	0	0	0	Lead changed - 6 times

TCU vs West Virginia
1/13/2018; 5:00 p.m. at WVU Coliseum, Morgantown, W.Va.
Scoring/Runs Reference



Period 1

TCU	VRun	Score	Margin	HRun	West Virginia
09:46 - MOORE LAYUP [P]	-	2-0	-2		
		2-2	0		PARDEE JUMPER - 09:25
		2-4	2	4-0	MULDROW LAYUP [P] [F] - 08:30
08:15 - AKOMOLAFE FT	-	3-4	1		
		3-5	2		KING FT - 06:35
		3-6	3	2-0	KING FT - 06:35
05:28 - RAMIREZ FT	-	4-6	2		
05:28 - RAMIREZ FT	2-0	5-6	1		
		5-8	3		KING JUMPER [P] - 05:07
		5-11	6	5-0	PARDEE 3PTR - 04:47
04:33 - RAY LAYUP [P]	-	7-11	4		
		7-13	6		MULDROW LAYUP [P] - 04:17
		7-16	9	5-0	JONES 3PTR - 03:57
		7-18	11	7-0	KING LAYUP [P] [F] - 03:32
02:55 - THOMPSON 3PTR	-	10-18	8		
02:24 - MOORE LAYUP [P]	5-0	12-18	6		
		12-19	7		EKHELAR FT - 01:42
		12-20	8	2-0	EKHELAR FT - 01:42
		12-22	10	4-0	RAY LAYUP [P] - 01:13
00:56 - HELLESSEY JUMPER	-	14-22	8		
		14-25	11		DAVENPORT 3PTR - 00:36
00:15 - RAY LAYUP [P]	-	16-25	9		
00:13 - RAY FT	3-0	17-25	8		

TCU vs West Virginia
1/13/2018; 5:00 p.m. at WVU Coliseum, Morgantown, W.Va.
Scoring/Runs Reference



Period 2

TCU	VRun	Score	Margin	HRun	West Virginia
		17-27	10		MULDROW LAYUP [P] [F] - 09:12
08:49 - OKONKWO LAYUP [P]	-	19-27	8		
08:23 - WOODS LAYUP [P]	4-0	21-27	6		
07:47 - THOMPSON LAYUP [P]	6-0	23-27	4		
		23-29	6		DAVENPORT JUMPER - 05:51
		23-30	7	3-0	DAVENPORT FT - 05:29
		23-32	9	5-0	KING LAYUP [P] - 03:59
03:45 - HELLESSEY 3PTR	-	26-32	6		
		26-35	9		DAVENPORT 3PTR - 03:34
02:04 - RAY JUMPER	-	28-35	7		
		28-37	9		MULDROW LAYUP [P] - 01:07
		28-39	11	4-0	KING LAYUP [P] [F] - 00:43
00:20 - RAY FT	-	29-39	10		
		29-40	11		DAVENPORT FT - 00:03
		29-41	12	2-0	DAVENPORT FT - 00:03

TCU vs West Virginia
1/13/2018; 5:00 p.m. at WVU Coliseum, Morgantown, W.Va.
Scoring/Runs Reference



Period 3

TCU	VRun	Score	Margin	HRun	West Virginia
09:16 - MOORE LAYUP [P]	-	31-41	10		
		31-44	13		DAVENPORT 3PTR - 07:49
		31-46	15	5-0	MULDROW JUMPER - 07:19
		31-49	18	8-0	RAY 3PTR - 06:19
05:51 - THOMPSON LAYUP [P]	-	33-49	16		
05:32 - MOORE FT	3-0	34-49	15		
04:37 - HEARD FT	4-0	35-49	14		
03:33 - OKONKWO JUMPER [P]	6-0	37-49	12		
		37-52	15		DAVENPORT 3PTR - 03:23
02:58 - OKONKWO LAYUP [P]	-	39-52	13		
02:57 - OKONKWO FT	3-0	40-52	12		
		40-54	14		MULDROW JUMPER - 02:07
01:37 - MOORE LAYUP [P]	-	42-54	12		
01:37 - MOORE FT	3-0	43-54	11		
01:33 - HEARD LAYUP [P] [F]	5-0	45-54	9		
		45-55	10		RAY FT - 01:00
00:42 - MOORE LAYUP [P]	-	47-55	8		
		47-58	11		RAY 3PTR - 00:30

TCU vs West Virginia
1/13/2018; 5:00 p.m. at WVU Coliseum, Morgantown, W.Va.
Scoring/Runs Reference



Period 4

TCU	VRun	Score	Margin	HRun	West Virginia
09:41 - THOMPSON 3PTR	-	50-58	8		
08:41 - WOODS FT	NaN-0	51-58	7		
07:43 - RAY FT	NaN-0	52-58	6		
		52-60	8		KING LAYUP [P] - 06:43
05:09 - OKONKWO LAYUP [P]	-	54-60	6		
		54-62	8		RAY JUMPER [P] - 04:51
		54-64	10	4-0	RAY LAYUP [P] [F] - 04:39
03:36 - OKONKWO FT	-	55-64	9		
03:36 - OKONKWO FT	2-0	56-64	8		
02:56 - AKOMOLAFE JUMPER	4-0	58-64	6		
02:47 - MOORE LAYUP [P]	6-0	60-64	4		
02:47 - MOORE FT	7-0	61-64	3		
01:55 - THOMPSON FT	8-0	62-64	2		
01:55 - THOMPSON FT	9-0	63-64	1		
00:50 - RAMIREZ FT	10-0	64-64	0		
		64-66	2		JONES JUMPER [P] - 00:31
00:08 - RAMIREZ LAYUP [P]	-	66-66	0		
		66-67	1		RAY FT - 00:05
		66-68	2	2-0	RAY FT - 00:05
00:05 - OKONKWO LAYUP [P]	-	68-68	0		

TCU vs West Virginia
1/13/2018; 5:00 p.m. at WVU Coliseum, Morgantown, W.Va.
Scoring/Runs Reference



Period 5

TCU	VRun	Score	Margin	HRun	West Virginia
04:29 - MOORE LAYUP [P]	-	70-68	-2		
03:24 - RAMIREZ FT	NaN-0	71-68	-3		
		71-69	-2		MULDROW FT - 02:11
		71-70	-1	2-0	MULDROW FT - 02:11
		71-72	1	4-0	MULDROW LAYUP [P] - 01:51
01:35 - THOMPSON LAYUP [P]	-	73-72	-1		
		73-74	1		RAY JUMPER - 01:09
00:04 - OKONKWO 3PTR	-	76-74	-2		



PERIOD 1

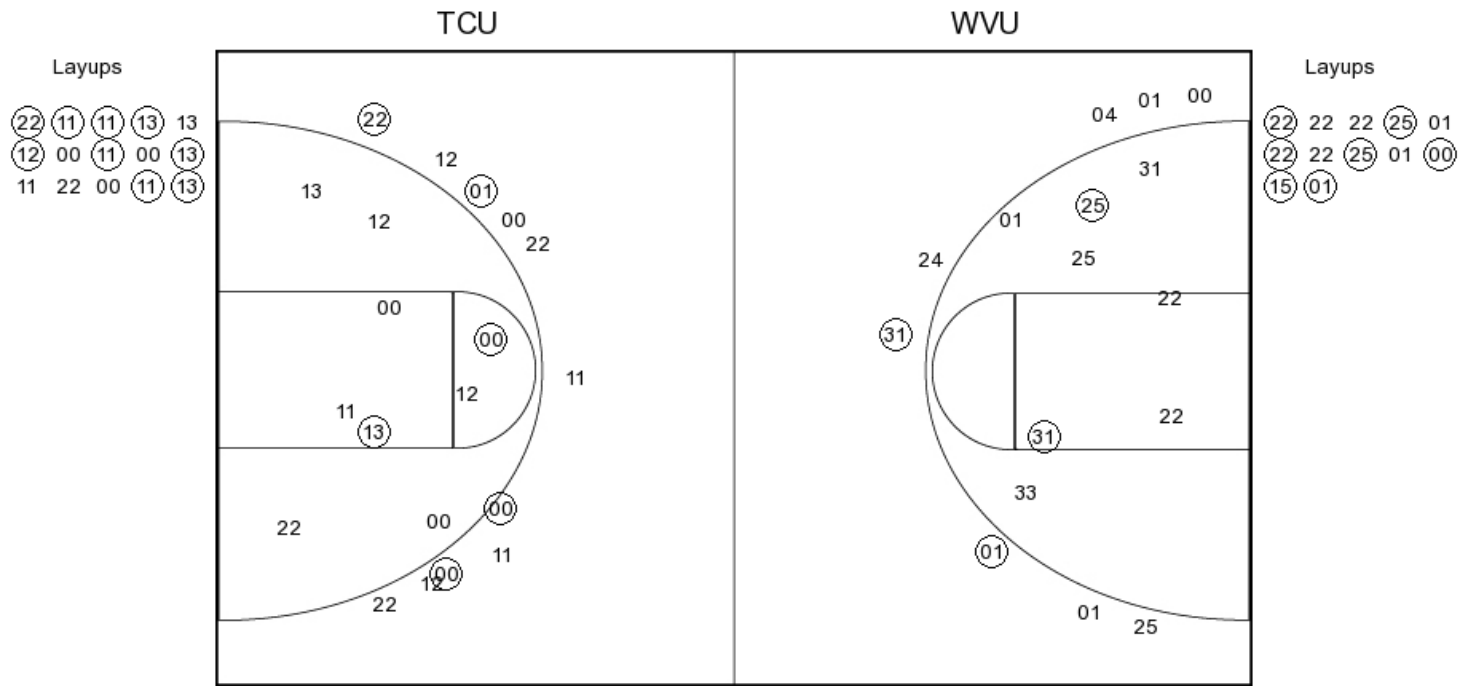

TCU PERIOD 1

FG Made	11
FG Attempted	28
3PFG Made	2
3PFG Attempted	8

WVU PERIOD 1

FG Made	15
FG Attempted	35
3PFG Made	4
3PFG Attempted	11



PERIOD 2

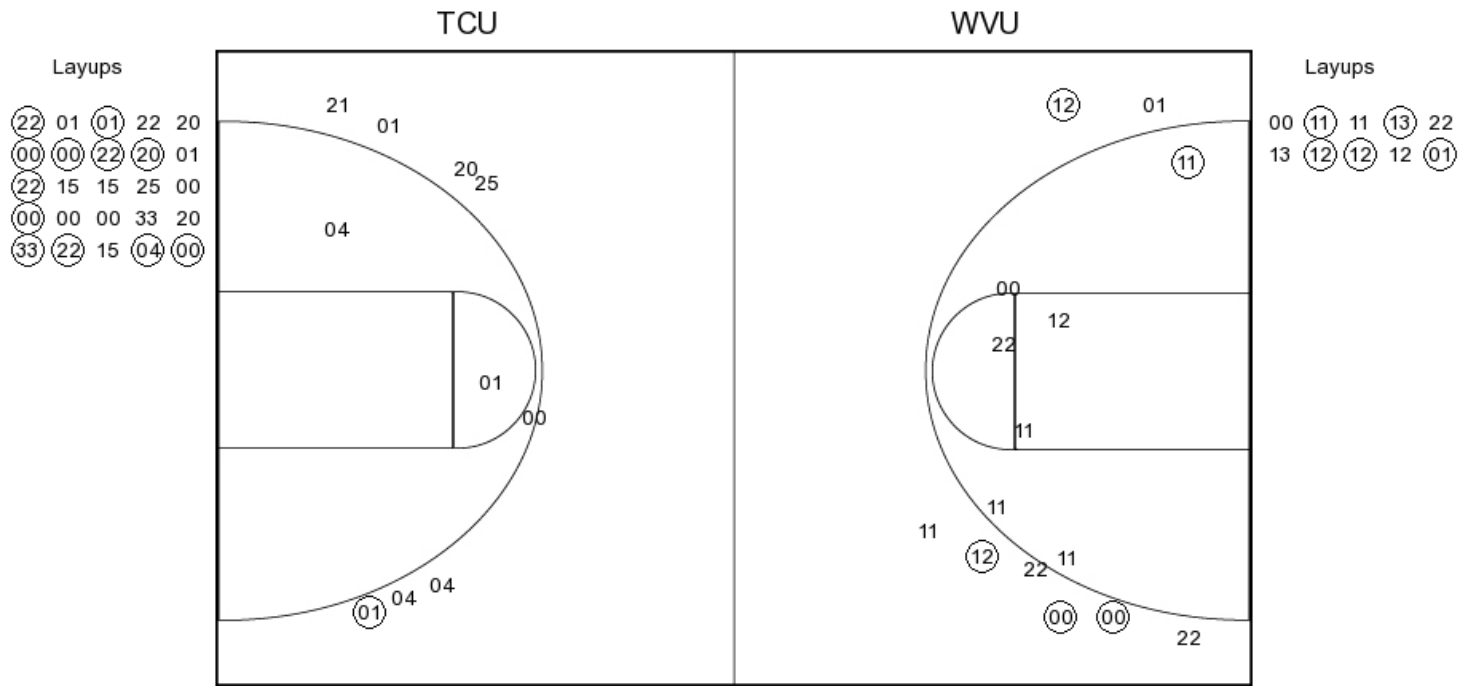

TCU PERIOD 2

FG Made
 FG Attempted
 3PFG Made
 3PFG Attempted

WVU PERIOD 2

FG Made
 FG Attempted
 3PFG Made
 3PFG Attempted



PERIOD 3

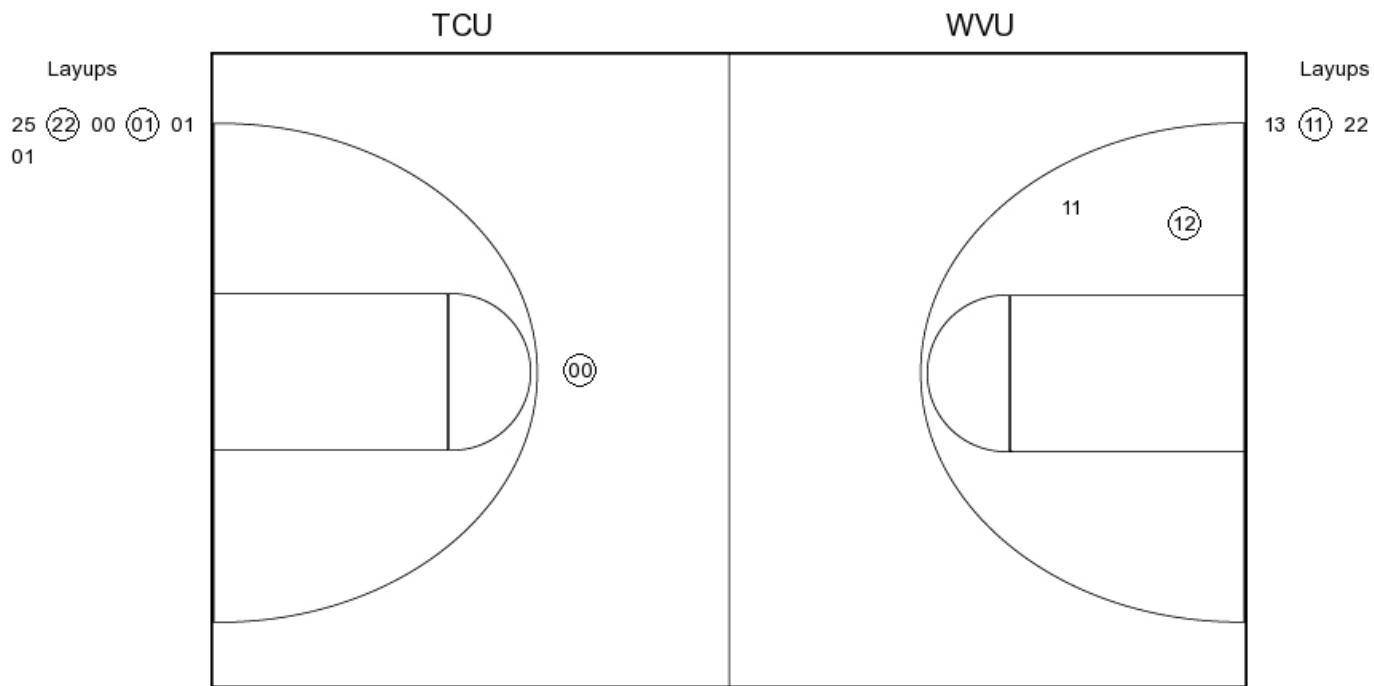

TCU PERIOD 3

FG Made	13
FG Attempted	34
3PFG Made	1
3PFG Attempted	7

WVU PERIOD 3

FG Made	10
FG Attempted	24
3PFG Made	4
3PFG Attempted	8



PERIOD 4

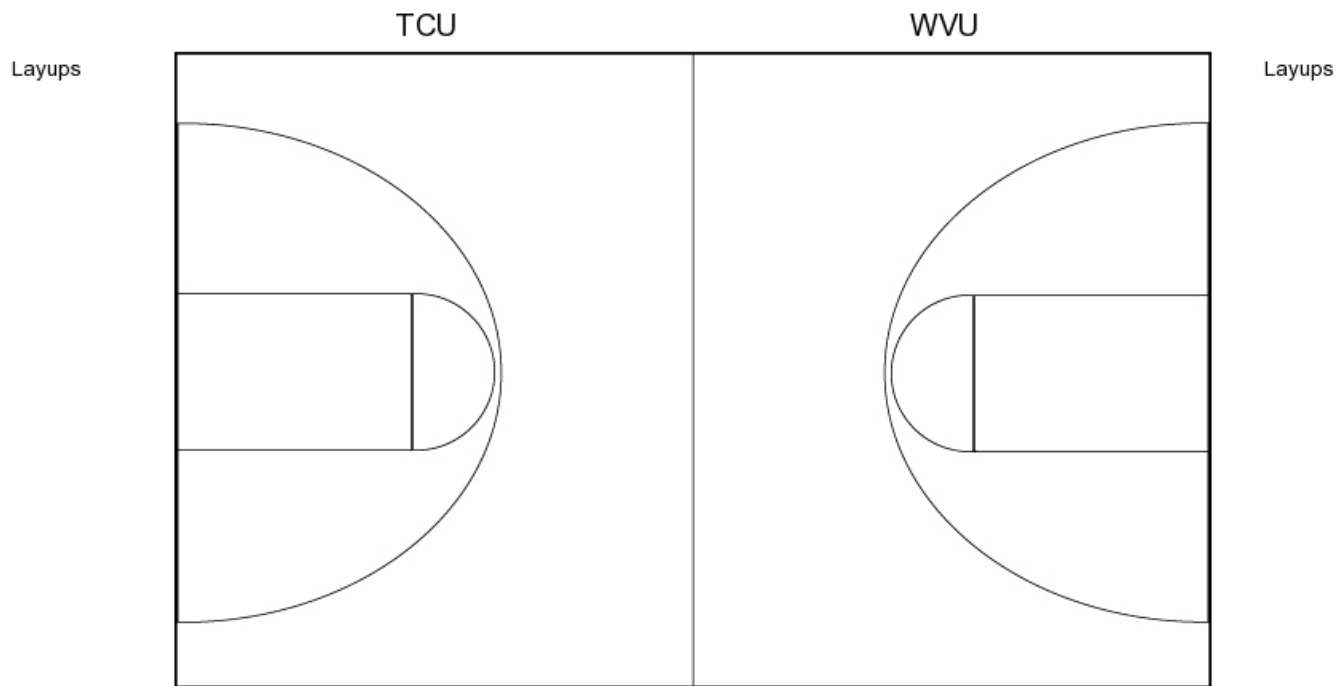

TCU PERIOD 4

FG Made
FG Attempted
3PFG Made
3PFG Attempted

WVU PERIOD 4

FG Made
FG Attempted
3PFG Made
3PFG Attempted



PERIOD 5

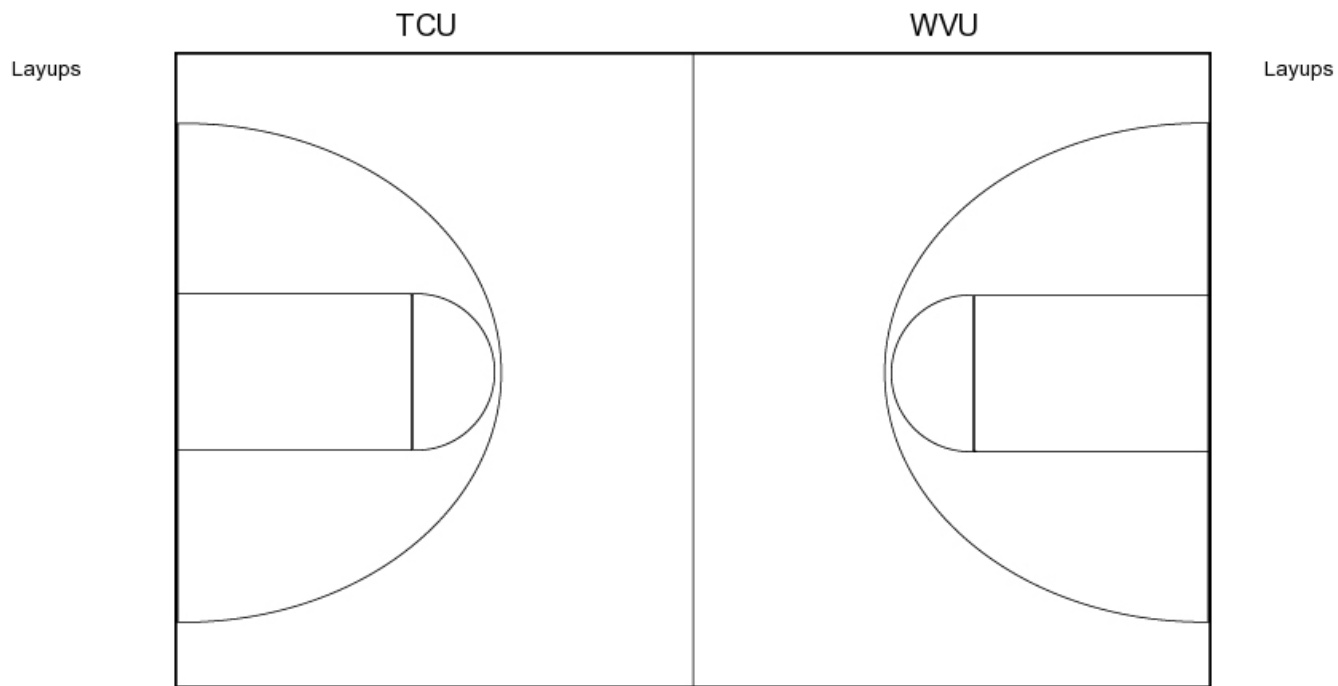

TCU PERIOD 5

FG Made
FG Attempted
3PFG Made
3PFG Attempted

WVU PERIOD 5

FG Made
FG Attempted
3PFG Made
3PFG Attempted



TCU

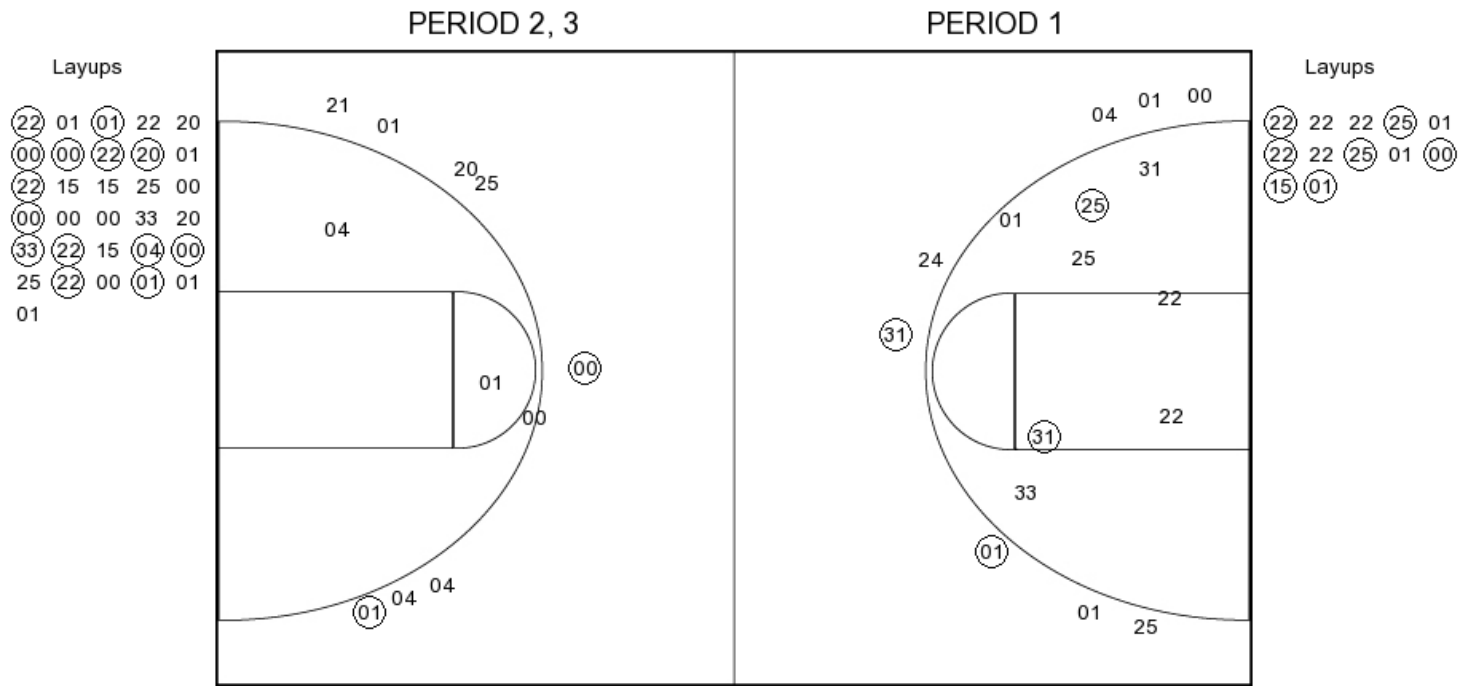

TCU PERIOD 1

FG Made	11
FG Attempted	28
3PFG Made	2
3PFG Attempted	8

TCU PERIOD 2

FG Made	
FG Attempted	
3PFG Made	
3PFG Attempted	



West Virginia

PERIOD 1

PERIOD 2, 3

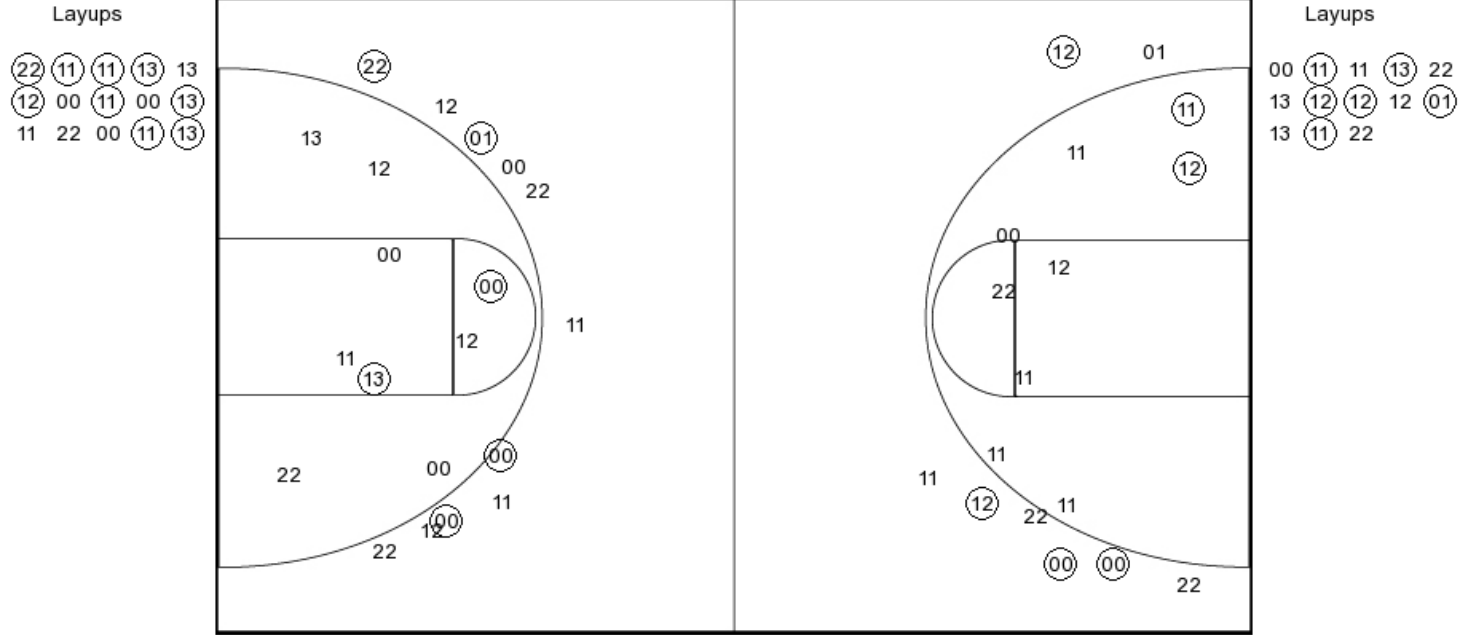

WVU PERIOD 1

FG Made	15
FG Attempted	35
3PFG Made	4
3PFG Attempted	11

WVU PERIOD 2

FG Made	
FG Attempted	
3PFG Made	
3PFG Attempted	